

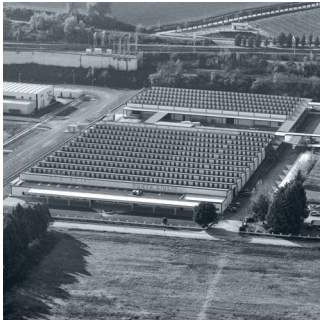

Physically challenged bathroom environments

Casual Collection

Physically challenged bathroom environments



Ponte Giulio is one of Europe's largest manufacturers of safety solutions for bathrooms, with a range of products suitable for hospitals, nursing homes, hotels and other commercial and residential buildings.

Ponte Giulio provides a range of products to satisfy the needs of the bathroom industry. The development of the company's product range over time has led to the creation of functional apparatus with more aesthetic appeal than other accessible bathroom products on the market.

Ponte Giulio is committed to creating inclusive living spaces by designing stylish bathrooms which improve quality of life for all whilst strictly complying with regulations.

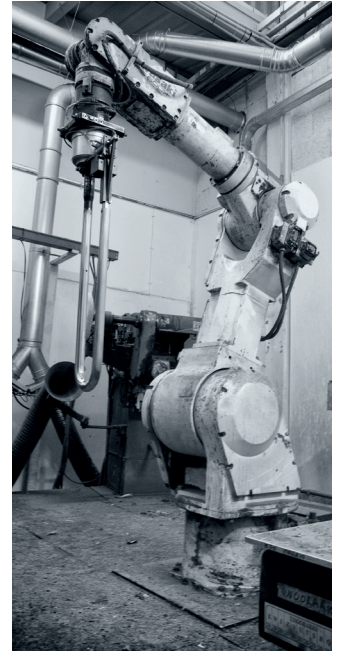
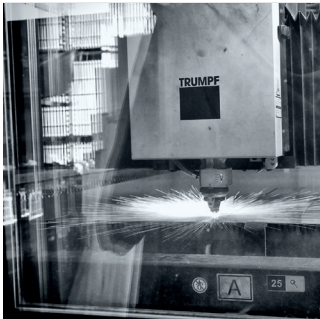
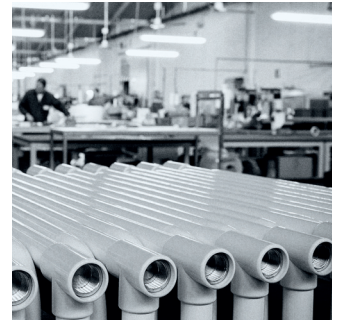

www.pontegiulio.com



Casual Collection



The indispensable characteristics for a safe bathroom, both in private and public environments, are: essential lines, affordable prices combined with total safety and quality, as well as long lasting life and easy maintenance.

The range of articles of Casual Collection are conceived and mainly addressed for the supplies to the building yards.



Physically challenged

Grab Rails



| | |
|--------------------------------|----|
| Tubocolor line | 04 |
| Paint line | 12 |
| Inox, satin finish line | 20 |

Seats and Stools



28

Sanitaryware



30

Bath accessories



34

General information



| | |
|----------------------------------|----|
| Flanges and fixing plates | 38 |
| Cleaning information | 39 |
| Alphabetical index | 40 |

Tubocolor Line

Tubocolor made the history of Ponte Giulio: the first proposal for helping disabled and elderly people into the bathroom led Ponte Giulio to the achievement of the Market Leadership. This collection of grab bars and helping systems has been conceived to offer a valid support and a total safety to all people inside a bathroom, considering as priority an easy installation and maintenance during the years.



Materials

Zinc plated steel Vinyl

Polyamide

Colours / Finishes

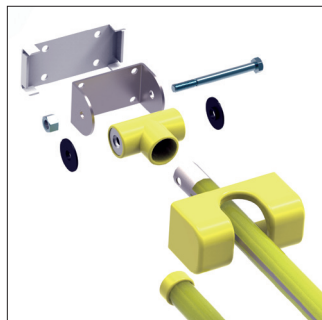
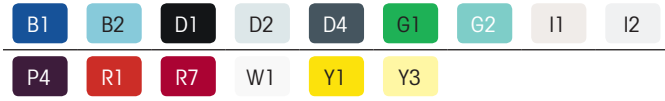

Basin area

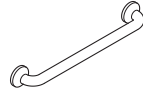

Straight safety grab bar
page 06

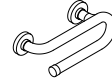

Straight safety grab bar with additional
towel holder arm
page 06

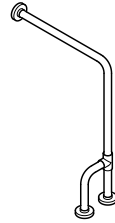

Side fixed safety grab bar
page 07

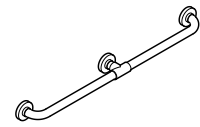

Straight safety grab bar, custom-tailored
page 06

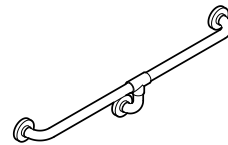

Safety handrail, custom-tailored
page 06

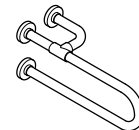

Side fixed safety grab bar
page 07



Vertical safety grab bar
page 07

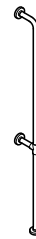

Wall-to-floor vertical safety grab bar
page 07



Ceiling-to-floor vertical safety grab bar
page 07

Basin area



Safety corner grab bar 135
page 07

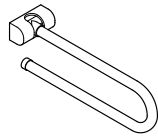

Safety folding grab bar
page 08

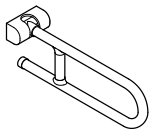

Safety folding grab bar
page 08

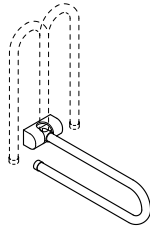

Safety folding side swivel grab bar
page 08

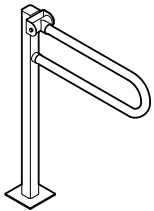

Safety folding grab bar on floor mounted
pedestal
page 08

Shower area

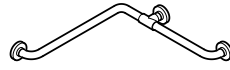

Safety handrail for corner installation
page 08



Safety handrail for corner installation,
custom-tailored
page 09

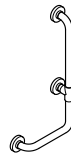

Safety grab bar with 90° corner
page 09

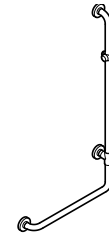

Safety grab bar with 90° corner
page 09

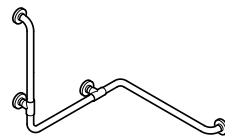

Safety handrail for corner installation
with vertical arm at one end
page 10

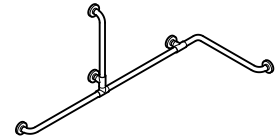

Safety handrail for corner installation
with vertical arm
page 10



Vertical safety shower grab bar equipped
with adjustable hand shower holder
page 09

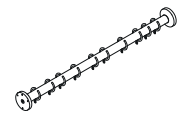

Straight shower curtain rod
page 11

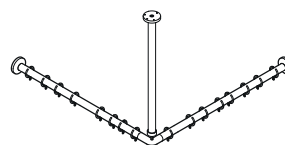

L-shaped shower curtain rod
page 11

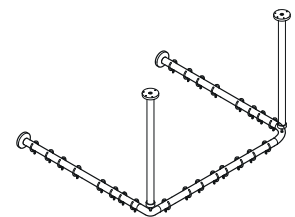

U-shaped shower curtain rod
page 11

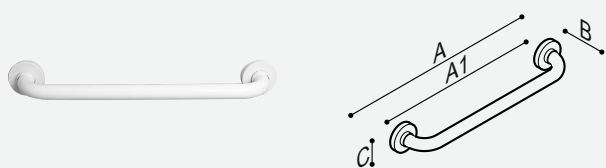

Straight safety grab bar



| Code | Dimensions (mm) | |
|------------|-----------------|------|
| | [AxBxC] | [A1] |
| G01JAS01xx | 300x100x80 | 220 |
| G01JAS02xx | 400x100x80 | 320 |
| G01JAS03xx | 500x100x80 | 420 |
| G01JAS04xx | 600x100x80 | 520 |
| G01JAS05xx | 700x100x80 | 620 |
| G01JAS06xx | 800x100x80 | 720 |
| G01JAS07xx | 900x100x80 | 820 |
| G01JAS41xx | 430x100x80 | 350 |
| G01JAS42xx | 530x100x80 | 450 |
| G01JAS43xx | 680x100x80 | 600 |
| G01JAS44xx | 980x100x80 | 900 |

Straight safety grab bar with additional towel holder arm



| Code | Dimensions (mm) | |
|---|-----------------|---------|
| | [AxBxC] | [A1xC1] |
| right execution | | |
|  | | |
| G01JER01xx | 400x100x171 | 260x111 |
| G01JER02xx | 600x100x171 | 460x111 |
| left execution | | |
|  | | |
| G01JEL01xx | 400x100x171 | 260x111 |
| G01JEL02xx | 600x100x171 | 460x111 |

Straight safety grab bar, custom-tailored

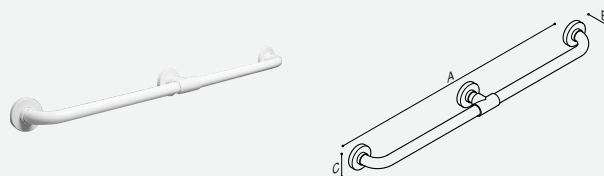

| Code | Dimensions (mm) | |
|------------|-----------------|--|
| | [BxC] | |
| G01JAS17xx | 100x80 | |

Note: The length (A) may be realized on request. For articles longer than 130 cm a third wall fixing flange kit will be foreseen.

Safety handrail, custom-tailored

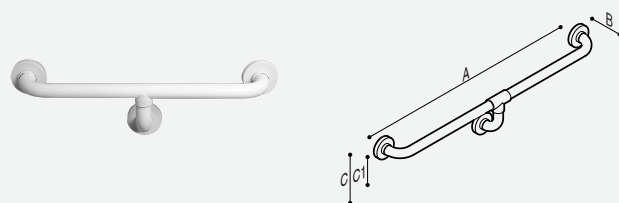

| Code | Dimensions (mm) | |
|------------|-----------------|------|
| | [BxC] | [C1] |
| G01JAS18xx | 100x210 | 130 |

Note: The length (A) may be realized on request. For articles longer than 130 cm a third wall fixing flange kit will be foreseen.



Side fixed safety grab bar

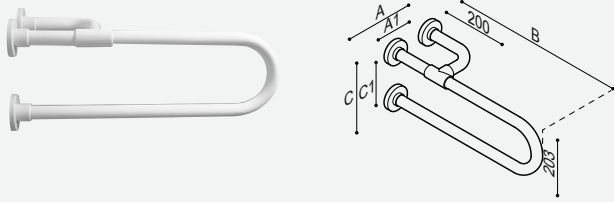

| Code | Dimensions (mm) | |
|------------|-----------------|---------|
| | [AxBxC] | [A1xC1] |
| G01JCS05xx | 225x600x250 | 145x170 |
| G01JCS07xx | 225x800x250 | 145x170 |

Vertical safety grab bar

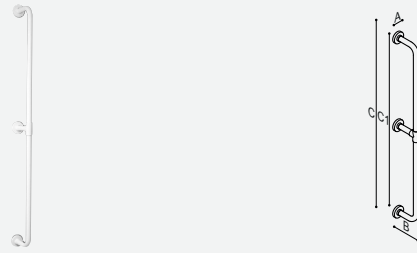

| Code | Dimensions (mm) | |
|------------|-----------------|------|
| | [AxBxC] | [C1] |
| G01JAS09xx | 80x175x1400 | 1320 |
| G01JAS10xx | 80x175x1600 | 1520 |
| G01JAS11xx | 80x175x1800 | 1720 |

Side fixed safety grab bar



| Code | Dimensions (mm) | |
|------------|-----------------|------|
| | [AxBxC] | [A1] |
| G01JCS38xx | 225x600x780 | 145 |
| G01JCS39xx | 225x800x780 | 145 |

Wall-to-floor vertical safety grab bar

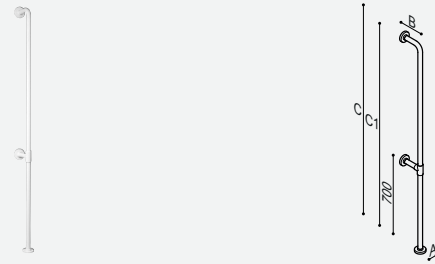

| Code | Dimensions (mm) | |
|------------|-----------------|------|
| | [AxBxC] | [C1] |
| G01JAS12xx | 80x175x1800 | 1760 |
| G01JAS13xx | 80x175x2000 | 1960 |

Ceiling-to-floor vertical safety grab bar

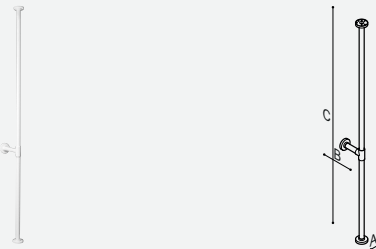

| Code | Dimensions (mm) | |
|------------|-----------------|--|
| | [A] | |
| G01JAS19xx | 80 | |

Note: The sizes (B) and (C) may be realized on request. For sizes longer than 230 cm a second wall fixing flange kit will be foreseen.

Safety corner grab bar 135



| Code | Dimensions (mm) | |
|------------|-----------------|---------|
| | [AxBxC] | [A1xC1] |
| G01JAS08xx | 550x100x295 | 470x215 |
| G01JAS20xx | 694x100x334 | 614x254 |

Safety handrail for corner installation

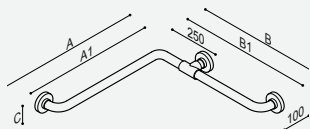

| Code | Dimensions (mm) | |
|------------|-----------------|----------|
| | [AxBxC] | [A1xB1] |
| G01JBS01xx | 660x660x80 | 620x620 |
| G01JBS02xx | 760x760x80 | 720x720 |
| G01JBS03xx | 1000x660x80 | 620x960 |
| G01JBS04xx | 1600x660x80 | 620x1560 |
| G01JBS05xx | 1700x760x80 | 720x1660 |

Safety folding side swivel grab bar

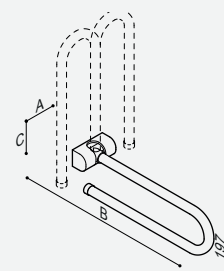

| Code | Dimensions (mm) | |
|------------|-----------------|--|
| | [AxBxC] | |
| G01JCS01xx | 135x600x217 | |
| G01JCS03xx | 135x800x217 | |

Safety folding grab bar

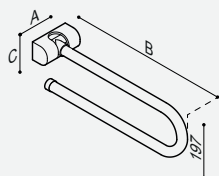

| Code | Dimensions (mm) | |
|------------|-----------------|--|
| | [AxBxC] | |
| G01JCS12xx | 135x600x215 | |
| G01JCS14xx | 135x800x215 | |

Paper roll holder for installation on grab bar

Code _____
F17AGN03xx



Safety folding grab bar

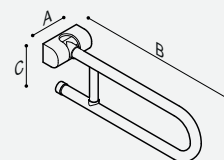

| Code | Dimensions (mm) | |
|------------|-----------------|--|
| | [AxBxC] | |
| G01JCS09xx | 110x600x217 | |
| G01JCS10xx | 110x800x217 | |

Supporting leg to the floor for folding grab bar

Code _____
G06JCS21W2



Paper roll holder for installation on grab bar

Code _____
F17AGN03xx



Paper roll holder for installation on grab bar

Code _____
F17AGN03xx



Safety folding grab bar on floor mounted pedestal



Code Dimensions (mm)
 [AxBxC]

G01JCS52xx 130x690x840

G01JCS53xx 135x880x840

Paper roll holder for installation on grab bar

Code
F17AGN03xx



Safety grab bar with 90° corner



Code Dimensions (mm)
 [AxBxC] [A1xC1]

right execution



G01JBR19xx 350x100x660 270x580

G01JBR20xx 660x100x660 580x580

left execution



G01JBL19xx 350x100x660 270x580

G01JBL20xx 660x100x660 580x580

Safety handrail for corner installation, custom-tailored

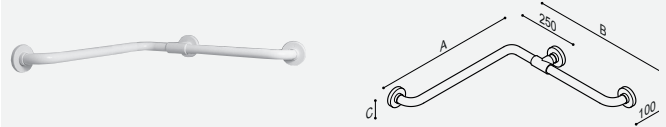

Code Dimensions (mm)
 [C]

G01JBS17xx 80

Note: The sizes (A) and (B) may be realized on request. For articles longer than 130 cm a third wall fixing flange kit on both sides will be foreseen. The smallest possible size is 350 mm.

Safety handrail for corner installation, custom-tailored

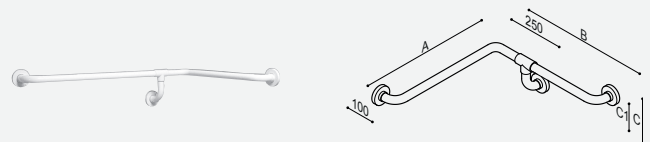

Code Dimensions (mm)
 [C] [C1]

G01JBS18xx 210 130

Note: The sizes (A) and (B) may be realized on request. For articles longer than 130 cm a third wall fixing flange kit on both sides will be foreseen. The smallest possible size is 350 mm.

Vertical safety shower grab bar equipped with adjustable hand shower holder

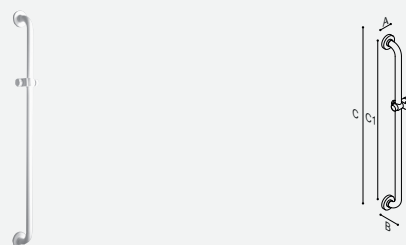

Code Dimensions (mm)
 [AxBxC] [C1]

G01JOS01xx 80x100x1200 1120

Grab Rails Tubocolor line

Safety grab bar with 90° corner



Code Dimensions (mm)
[AxBxC] [A1xC1]

right execution

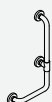

G01JOR01xx 660x100x1200 580x1120

left execution



G01JOL01xx 660x100x1200 580x1120

Safety handrail for corner installation with vertical arm at one end

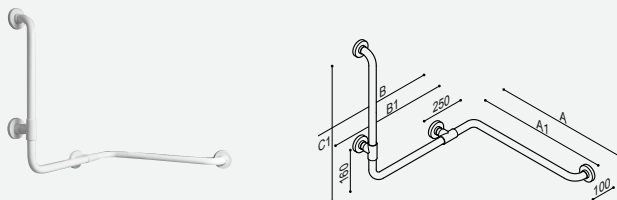

Code Dimensions (mm)
[AxBxC] [A1xB1xC1]

G01JBS06xx 660x660x660 620x620x580

G01JBS07xx 760x760x760 720x720x680

G01JBS08xx 1000x660x660 960x620x580

G01JBS09xx 1600x660x660 1560x620x580

G01JBS10xx 1700x760x760 1660x720x680



Safety handrail for corner installation with vertical arm

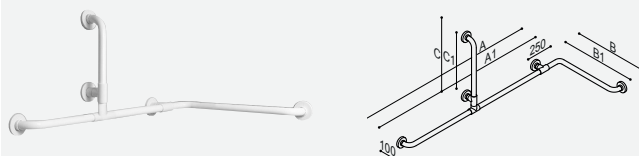

Code Dimensions (mm)
[AxBxC] [A1xB1xC1]

G01JBS11xx 1600x660x660 1560x620x580

G01JBS12xx 1700x760x760 1660x720x680



L-shaped shower curtain rod

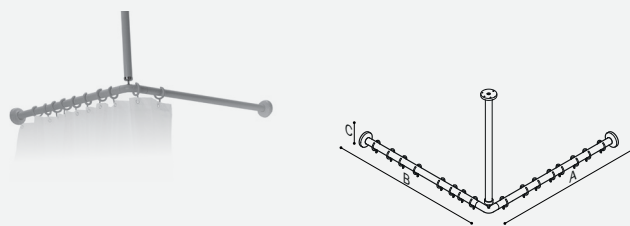

| Code | Dimensions (mm) | |
|------------|-----------------|-----------|
| | [AxBxC] | [A1xB1] |
| G01JRS11xx | 840x840x80 | 800x800 |
| G01JRS12xx | 940x940x80 | 900x900 |
| G01JRS13xx | 1040x1040x80 | 1000x1000 |
| G01JRS14xx | 1240x1240x80 | 1200x1200 |
| G01JRS15xx | 1540x1540x80 | 1500x1500 |

Straight shower curtain rod

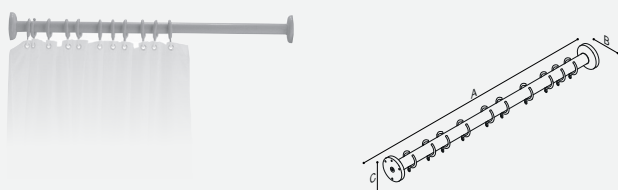

| Code | Dimensions (mm) |
|------------|-----------------|
| | [AxBxC] |
| G01JRS02xx | 900x80x80 |
| G01JRS03xx | 1000x80x80 |
| G01JRS04xx | 1100x80x80 |
| G01JRS05xx | 1200x80x80 |
| G01JRS06xx | 1300x80x80 |
| G01JRS07xx | 1400x80x80 |
| G01JRS08xx | 1500x80x80 |
| G01JRS09xx | 1600x80x80 |

Junction shower rod for ceiling mounting

| Code | (mm) |
|------------|------|
| G01JTS10xx | 400 |
| G01JTS11xx | 500 |
| G01JTS12xx | 600 |
| G01JTS13xx | 1000 |



U-shaped shower curtain rod

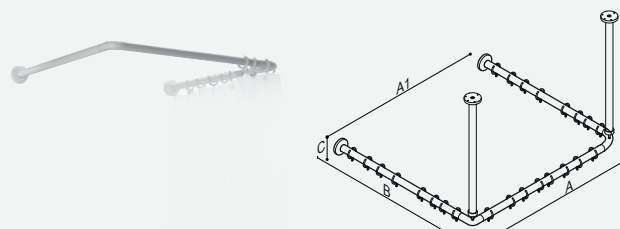

| Code | Dimensions (mm) | |
|------------|-----------------|------|
| | [AxBxC] | [A1] |
| G01JRS22xx | 1080x1000x80 | 1000 |
| G01JRS23xx | 1280x1200x80 | 1200 |
| G01JRS24xx | 1580x1500x80 | 1500 |

Junction shower rod for ceiling mounting

| Code | (mm) |
|------------|------|
| G01JTS10xx | 400 |
| G01JTS11xx | 500 |
| G01JTS12xx | 600 |
| G01JTS13xx | 1000 |



Junction shower rod for ceiling mounting

| Code | (mm) |
|------------|------|
| G01JTS10xx | 400 |
| G01JTS11xx | 500 |
| G01JTS12xx | 600 |
| G01JTS13xx | 1000 |



Paint Line

The indispensable characteristics for a safe bathroom, both in private and public environments, are: essential lines, affordable prices combined with total safety and quality. This "Paint" Collection of classic style shapes is offered in epoxy powder external finish and polyamide flange cover for hiding the fixing screws.



Materials

Steel

Aluminium

Polyamide

Basin area

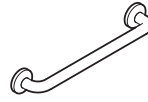

Straight safety grab bar
page 14



Side fixed safety grab bar
page 15



Safety handrail, custom-tailored
page 14

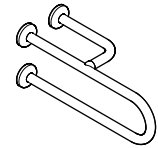

Side fixed safety grab bar
page 15



Vertical safety grab bar
page 14

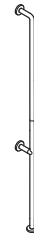

Wall-to-floor vertical safety grab bar
page 15

Colours / Finishes

W2

W7

"W2" code refers to finishing with epoxy-polyester powder paint.
"W7" code refers to finishing with "Rilsan®" powder paint.

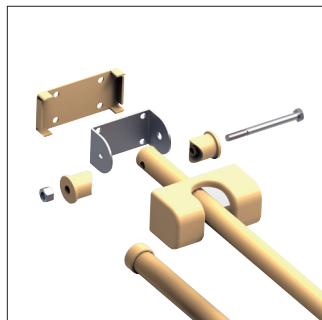

Basin area

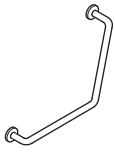

Safety corner grab bar 135
page 14

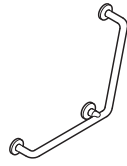

Safety corner grab bar 135
page 14

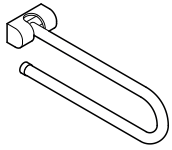

Safety folding grab bar
page 16

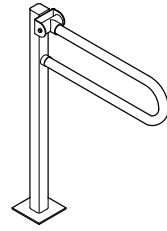

Safety folding grab bar on floor mounted
pedestal
page 16

Shower area



Safety handrail for corner installation
page 14

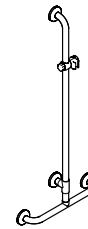

T-shaped safety handrail, equipped with
adjustable hand shower holder
page 17

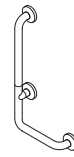

Safety grab bar with 90° corner
page 15



Safety grab bar with 90° corner
page 15

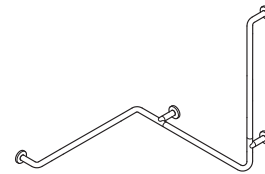

Safety handrail for corner installation
with vertical arm at one end
page 17

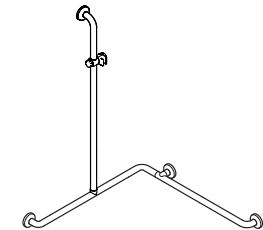

Safety handrail for corner installation
with vertical arm
page 17



Straight shower curtain rod
page 18

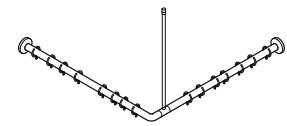

L-shaped shower curtain rod
page 18

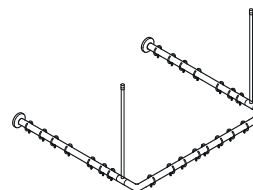

U-shaped shower curtain rod
page 18

Straight safety grab bar

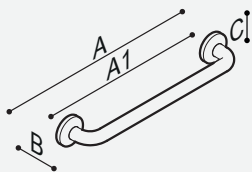

| Code | Dimensions (mm) | |
|------------|-----------------|------|
| | [AxBxC] | [A1] |
| G06JAS02W2 | 380x100x80 | 300 |
| G06JAS13W2 | 450x100x80 | 370 |
| G06JAS03W2 | 530x100x80 | 450 |
| G06JAS05W2 | 680x100x80 | 600 |
| G06JAS14W2 | 800x100x80 | 720 |
| G06JAS06W2 | 980x100x80 | 900 |
| G06JAS02W7 | 380x100x80 | 300 |
| G06JAS13W7 | 450x100x80 | 370 |
| G06JAS03W7 | 530x100x80 | 450 |
| G06JAS05W7 | 680x100x80 | 600 |
| G06JAS14W7 | 800x100x80 | 720 |
| G06JAS06W7 | 980x100x80 | 900 |

Safety handrail for corner installation

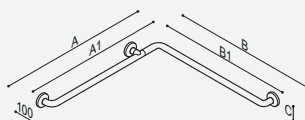

| Code | Dimensions (mm) | |
|------------|-----------------|---------|
| | [AxBxC] | [A1xB1] |
| G06JBS01W2 | 705x705x80 | 665x665 |
| G06JBS02W2 | 805x805x80 | 765x765 |
| G06JBS03W2 | 1000x1000x80 | 960x960 |
| G06JBS01W7 | 705x705x80 | 665x665 |
| G06JBS02W7 | 805x805x80 | 765x765 |
| G06JBS03W7 | 1000x1000x80 | 960x960 |

Safety corner grab bar 135

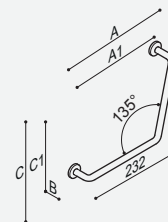

| Code | Dimensions (mm) | |
|------------|-----------------|---------|
| | [AxBxC] | [A1xC1] |
| G06JAS08W2 | 480x100x248 | 400x168 |
| G06JAS08W7 | 480x100x248 | 400x168 |

Safety corner grab bar 135, equipped with a third wall fixing kit

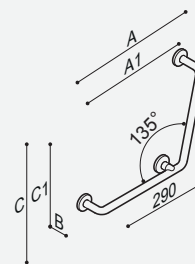

| Code | Dimensions (mm) | |
|------------|-----------------|---------|
| | [AxBxC] | [A1xC1] |
| G06JAS09W2 | 698x100x336 | 618x256 |
| G06JAS09W7 | 698x100x336 | 618x256 |

Vertical safety grab bar



| Code | Dimensions (mm) | |
|------------|-----------------|------|
| | [AxBxC] | [C1] |
| G06JAS10W2 | 80x175x1600 | 1520 |
| G06JAS10W7 | 80x175x1600 | 1520 |

Wall-to-floor vertical safety grab bar

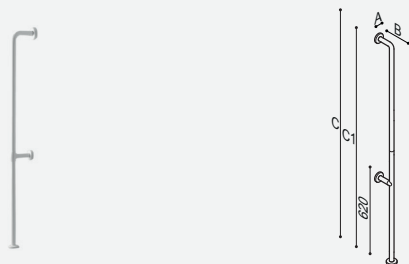

| Code | Dimensions (mm) | |
|------------|-----------------|------|
| | [AxBxC] | [C1] |
| G06JAS12W2 | 80x199x1800 | 1760 |
| G06JAS12W7 | 80x199x1800 | 1760 |

Safety grab bar with 90° corner



| Code | Dimensions (mm) | |
|-----------------|-----------------|---------|
| | [AxBxC] | [A1xC1] |
| right execution | | |
| G06JBR19W2 | 430x100x740 | 350x660 |
| G06JBR19W7 | 430x100x740 | 350x660 |

| | | |
|----------------|-------------|---------|
| left execution | | |
| G06JBL19W2 | 430x100x740 | 350x660 |
| G06JBL19W7 | 430x100x740 | 350x660 |

Side fixed safety grab bar

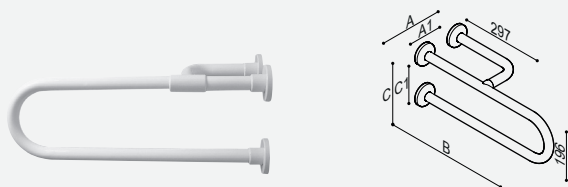

| Code | Dimensions (mm) | |
|------------|-----------------|---------|
| | [AxBxC] | [A1xB1] |
| G06JCS05W2 | 230x600x244 | 150x164 |
| G06JCS07W2 | 230x800x244 | 150x164 |
| G06JCS05W7 | 230x600x244 | 150x164 |
| G06JCS07W7 | 230x800x244 | 150x164 |

Safety shower grab bar with 90° corner, equipped with adjustable hand shower holder

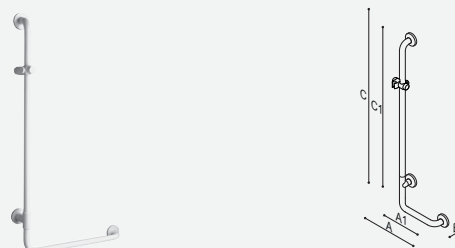

| Code | Dimensions (mm) | |
|-----------------|-----------------|----------|
| | [AxBxC] | [A1xC1] |
| right execution | | |
| G06JOR01W2 | 450x100x1264 | 370x1184 |
| G06JOR01W7 | 450x100x1264 | 370x1184 |

| | | |
|----------------|--------------|----------|
| left execution | | |
| G06JOL01W2 | 450x100x1264 | 370x1184 |
| G06JOL01W7 | 450x100x1264 | 370x1184 |

Side fixed safety grab bar

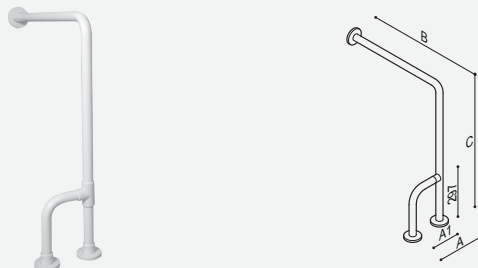

| Code | Dimensions (mm) | |
|------------|-----------------|------|
| | [AxBxC] | [A1] |
| G06JCS38W2 | 230x600x780 | 150 |
| G06JCS39W2 | 230x800x780 | 150 |
| G06JCS38W7 | 230x600x780 | 150 |
| G06JCS39W7 | 230x800x780 | 150 |

Grab Rails Paint line

Safety folding grab bar

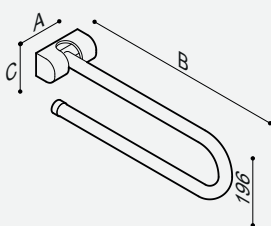
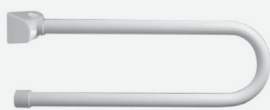

Code Dimensions (mm)
[AxBxC]

G06JCS12W2 135x600x214

G06JCS14W2 135x800x214

G06JCS12W7 135x600x214

G06JCS14W7 135x800x214

Supporting leg to the floor for folding grab bar

Code

G06JCS21W2



Paper roll holder for installation on grab bar

Code

F17AGN03xx



Safety folding grab bar on floor mounted pedestal

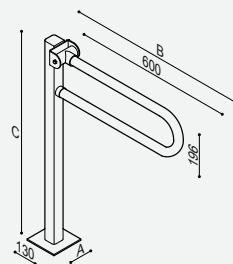

Code Dimensions (mm)
[AxBxC]

G06JCS52W2 130x690x840

G06JCS52W7 130x690x840

Paper roll holder for installation on grab bar

Code

F17AGN03xx



Safety handrail for corner installation with vertical arm, equipped with adjustable hand shower holder

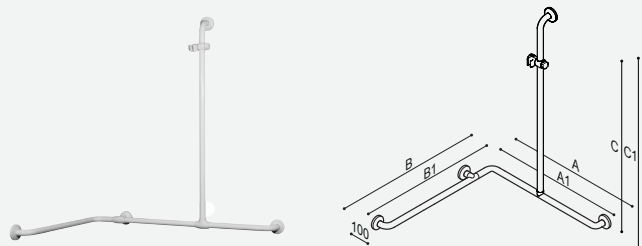

| Code | Dimensions (mm) | |
|------|-----------------|------------|
| | [AxBxC] | [A1xB1xC1] |

right execution



| | | |
|------------|--------------|--------------|
| G06JBR04W2 | 750x750x1264 | 710x710x1184 |
|------------|--------------|--------------|

| | | |
|------------|--------------|--------------|
| G06JBR04W7 | 750x750x1264 | 710x710x1184 |
|------------|--------------|--------------|

left execution



| | | |
|------------|--------------|--------------|
| G06JBL04W2 | 750x750x1264 | 710x710x1184 |
|------------|--------------|--------------|

| | | |
|------------|--------------|--------------|
| G06JBL04W7 | 750x750x1264 | 710x710x1184 |
|------------|--------------|--------------|

Safety handrail for corner installation with vertical arm at one end

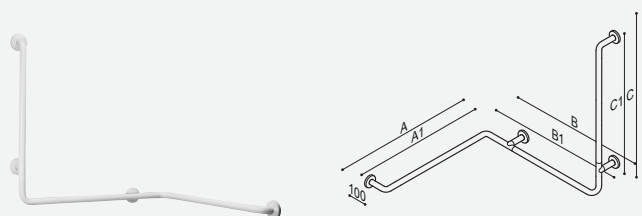

| Code | Dimensions (mm) | |
|------|-----------------|------------|
| | [AxBxC] | [A1xB1xC1] |

right execution



| | | |
|------------|--------------|--------------|
| G06JBR06W2 | 705x705x1264 | 665x665x1184 |
|------------|--------------|--------------|

| | | |
|------------|--------------|--------------|
| G06JBR06W7 | 705x705x1264 | 665x665x1184 |
|------------|--------------|--------------|

left execution



| | | |
|------------|--------------|--------------|
| G06JBL06W2 | 705x705x1264 | 665x665x1184 |
|------------|--------------|--------------|

| | | |
|------------|--------------|--------------|
| G06JBL06W7 | 705x705x1264 | 665x665x1184 |
|------------|--------------|--------------|

Vertical safety shower grab bar equipped with adjustable hand shower holder

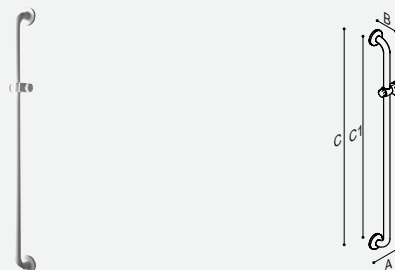

| Code | Dimensions (mm) | |
|------|-----------------|------|
| | [AxBxC] | [C1] |

| | | |
|------------|-------------|------|
| G06JOS01W2 | 1280x100x80 | 1200 |
|------------|-------------|------|

| | | |
|------------|-------------|------|
| G06JOS01W7 | 1280x100x80 | 1200 |
|------------|-------------|------|

T-shaped safety handrail, equipped with adjustable hand shower holder



| Code | Dimensions (mm) | |
|------|-----------------|---------|
| | [AxBxC] | [A1xC1] |

| | | |
|------------|--------------|----------|
| G06JBS16W2 | 550x100x1264 | 470x1184 |
|------------|--------------|----------|

| | | |
|------------|--------------|----------|
| G06JBS16W7 | 550x100x1264 | 470x1184 |
|------------|--------------|----------|

Straight shower curtain rod

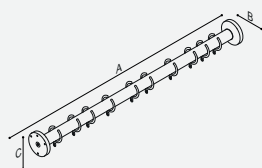

Code Dimensions (mm)
[AxBxC]

| | |
|------------|------------|
| G06JRS01W2 | 800x80x80 |
| G06JRS02W2 | 900x80x80 |
| G06JRS03W2 | 1000x80x80 |
| G06JRS04W2 | 1100x80x80 |
| G06JRS05W2 | 1200x80x80 |
| G06JRS06W2 | 1300x80x80 |

| | |
|------------|------------|
| G06JRS01W7 | 800x80x80 |
| G06JRS02W7 | 900x80x80 |
| G06JRS03W7 | 1000x80x80 |
| G06JRS04W7 | 1100x80x80 |
| G06JRS05W7 | 1200x80x80 |
| G06JRS06W7 | 1300x80x80 |

L-shaped shower curtain rod

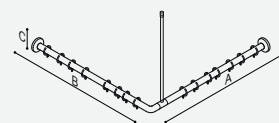
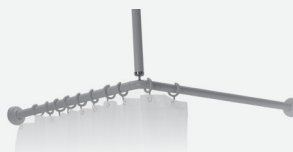

Code Dimensions (mm)
[AxBxC] [A1xB1]

| | | |
|------------|--------------|-----------|
| G06JRS10W2 | 790x940x80 | 750x900 |
| G06JRS11W2 | 840x840x80 | 800x800 |
| G06JRS12W2 | 940x940x80 | 900x900 |
| G016RS13W2 | 1040x1040x80 | 1000x1000 |
| G06JRS14W2 | 1240x1240x80 | 1200x1200 |
| G06JRS15W2 | 1540x1540x80 | 1500x1500 |

| | | |
|------------|--------------|-----------|
| G06JRS10W7 | 790x940x80 | 750x900 |
| G06JRS11W7 | 840x840x80 | 800x800 |
| G06JRS12W7 | 940x940x80 | 900x900 |
| G016RS13W7 | 1040x1040x80 | 1000x1000 |
| G06JRS14W7 | 1240x1240x80 | 1200x1200 |
| G06JRS15W7 | 1540x1540x80 | 1500x1500 |

Junction shower rod for ceiling mounting

| | |
|----------|------|
| Code | (mm) |
| G30JTS01 | 450 |

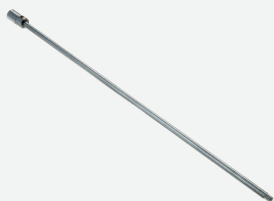

Junction shower rod for ceiling mounting

| | |
|----------|------|
| Code | (mm) |
| G30JTS01 | 450 |



U-shaped shower curtain rod

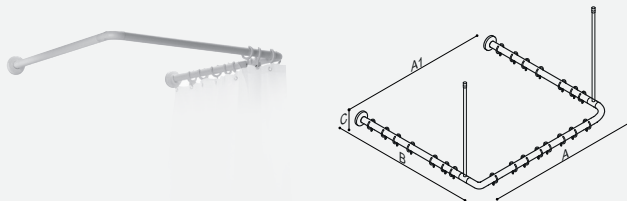

| Code | Dimensions (mm) | |
|------------|-----------------|------|
| | [AxBxC] | [A1] |
| G06JRS25W2 | 650x980x650 | 900 |
| G06JRS20W2 | 800x880x800 | 800 |
| G06JRS21W2 | 900x980x900 | 900 |
| G06JRS22W2 | 1000x1080x1000 | 1000 |
| G06JRS23W2 | 1200x1280x1200 | 1200 |
| G06JRS24W2 | 1500x1580x1500 | 1500 |
| G06JRS25W7 | 650x980x650 | 900 |
| G06JRS20W7 | 800x880x800 | 800 |
| G06JRS21W7 | 900x980x900 | 900 |
| G06JRS22W7 | 1000x1080x1000 | 1000 |
| G06JRS23W7 | 1200x1280x1200 | 1200 |
| G06JRS24W7 | 1500x1580x1500 | 1500 |

Junction shower rod for ceiling mounting

| Code | (mm) |
|----------|------|
| G30JTS01 | 450 |

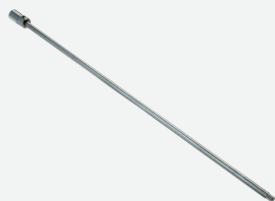

Inox, satin finish Line
satin finish

The satin stainless steel makes the products of this range to be ideal for use in busy public environments. Each single item is manufactured in stainless steel AISI 304 offering the guarantee of a longer life, a minimized maintenance and an easy cleaning.



Materials

Stainless steel

Aluminium

Basin area

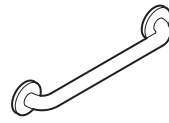

Straight safety grab bar
page 22



Side fixed safety grab bar
page 22



Safety handrail, custom-tailored
page 23

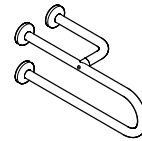

Side fixed safety grab bar
page 23



Vertical safety grab bar
page 23

Colours / Finishes

N1

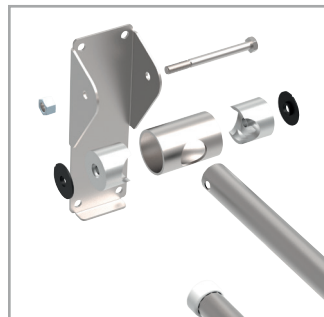

Basin area



Safety corner grab bar 135
page 22



Safety corner grab bar 135
page 22

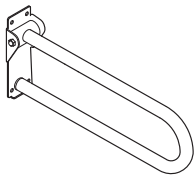

Safety folding grab bar
page 24

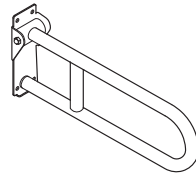

Safety folding grab bar on floor mounted
pedestal
page 24

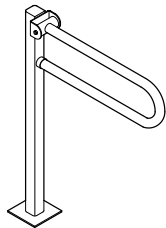

Safety folding grab bar on floor mounted
pedestal
page 23

Shower area



Safety handrail for corner installation
page 23



T-shaped safety handrail, equipped with
adjustable hand shower holder
page 23

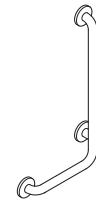

Safety grab bar with 90° corner
page 22

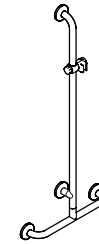

Safety grab bar with 90° corner
page 25

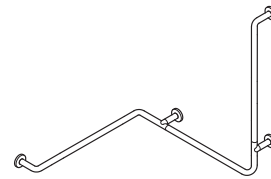

Safety handrail for corner installation
with vertical arm at one end
page 25

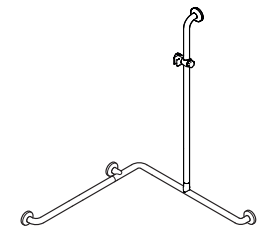

Safety handrail for corner installation
with vertical arm
page 25

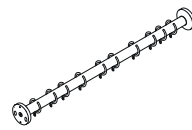

Straight shower curtain rod
page 26

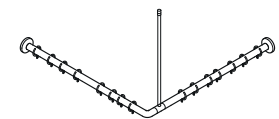

L-shaped shower curtain rod
page 26

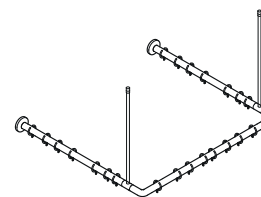

U-shaped shower curtain rod
page 26

Straight safety grab bar

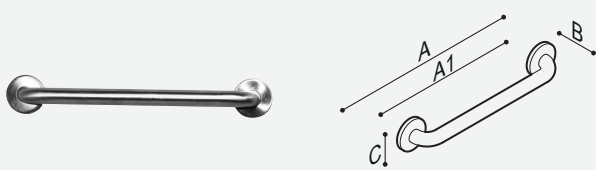

| Code | Dimensions (mm) | |
|----------|-----------------|------|
| | [AxBxC] | [A1] |
| G55JAS01 | 383x72x78 | 305 |
| G55JAS02 | 484x72x78 | 406 |
| G55JAS03 | 535x72x78 | 457 |
| G55JAS04 | 688x72x78 | 610 |
| G55JAS05 | 840x72x78 | 762 |
| G55JAS06 | 891x72x78 | 813 |
| G55JAS07 | 992x72x78 | 914 |

Safety corner grab bar 135, equipped with a third wall fixing kit

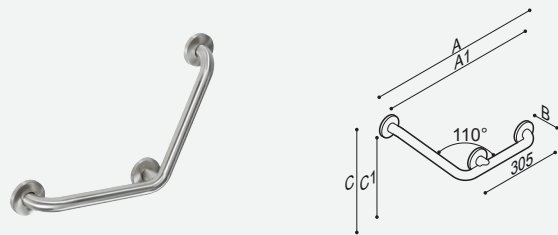

| Code | Dimensions (mm) | |
|----------|-----------------|---------|
| | [AxBxC] | [A1xC1] |
| G55JAS14 | 696x72x334 | 618x256 |

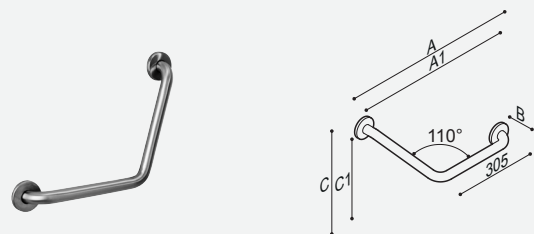

Safety corner grab bar 135

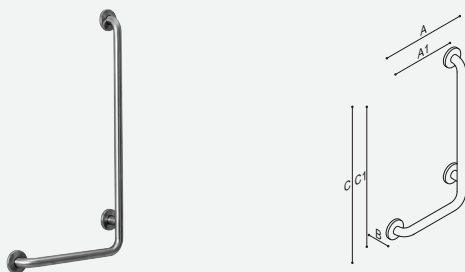

| Code | Dimensions (mm) | |
|----------|-----------------|---------|
| | [AxBxC] | [A1xC1] |
| G55JAS15 | 487x72x364 | 409x286 |

Safety grab bar with 90° corner

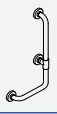

| Code | Dimensions (mm) | |
|---|-----------------|---------|
| | [AxBxC] | [A1xC1] |
| right execution | | |
|  | | |
| G55JBR19 | 484x72x891 | 406x813 |
| left execution | | |
|  | | |
| G55JBL19 | 484x72x891 | 406x813 |

Wall-to-floor vertical safety grab bar



| Code | Dimensions (mm) | |
|----------|-----------------|------|
| | [AxBxC] | [A1] |
| G55JCS38 | 205x800x877 | 127 |

Side fixed safety grab bar

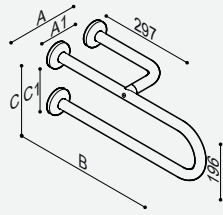

| Code | Dimensions (mm) | |
|----------|-----------------|---------|
| | [AxBxC] | [A1xC1] |
| G55JCS05 | 288x600x242 | 150x164 |
| G55JCS07 | 288x800x242 | 150x164 |

Safety shower grab bar with 90° corner, equipped with adjustable hand shower holder

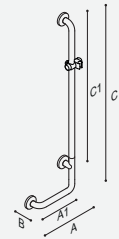

| Code | Dimensions (mm) | |
|------|-----------------|---------|
| | [AxBxC] | [A1xC1] |

right execution



| | | |
|----------|-------------|----------|
| G55JOR01 | 448x72x1262 | 370x1184 |
|----------|-------------|----------|

left execution



| | | |
|----------|-------------|----------|
| G55JOL01 | 448x72x1262 | 370x1184 |
|----------|-------------|----------|

Safety handrail for corner installation

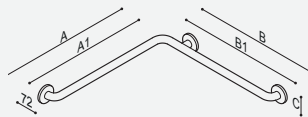

| Code | Dimensions (mm) | |
|----------|-----------------|---------|
| | [AxBxC] | [A1xB1] |
| G55JBS03 | 703x703x78 | 664x664 |
| G55JBS04 | 703x1007x78 | 664x968 |

Safety folding grab bar on floor mounted pedestal

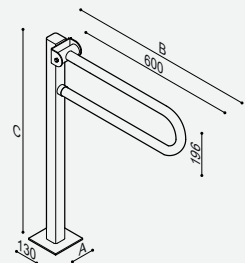

| Code | Dimensions (mm) | |
|----------|-----------------|--|
| | [AxBxC] | |
| G55JCS16 | 130x690x840 | |

Vertical safety grab bar

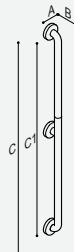

| Code | Dimensions (mm) | |
|----------|-----------------|------|
| | [AxBxC] | [C1] |
| G55JAS11 | 78x72x1399 | 1321 |

Paper roll holder for installation on grab bar

Code
F17AGN03xx



Safety folding grab bar

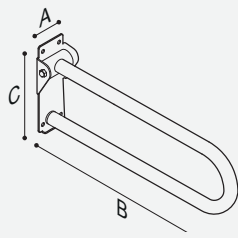

Code Dimensions (mm)
[AxBxC]

G55JCS09 75x600x250

G55JCS10 75x800x250

Safety folding grab bar

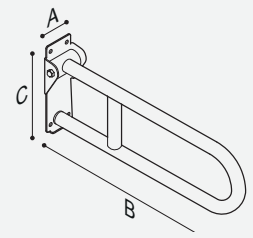

Code Dimensions (mm)
[AxBxC]

G55JCS12 75x600x250

G55JCS14 75x800x250

Supporting leg to the floor for folding grab bar

Code

G06JCS21W2



Supporting leg to the floor for folding grab bar

Code

G06JCS21W2



Paper roll holder for installation on grab bar

Code

F17AGN03xx



Paper roll holder for installation on grab bar

Code

F17AGN03xx



Safety handrail for corner installation with vertical arm, equipped with adjustable hand shower holder

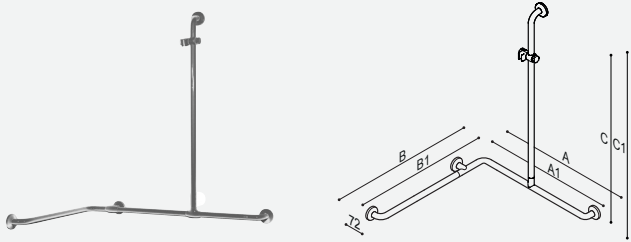

| Code | Dimensions (mm) | |
|------|-----------------|------------|
| | [AxBxC] | [A1xB1xC1] |

right execution



| | | |
|-----------------|--------------|--------------|
| G55JBR04 | 749x749x1262 | 710x710x1184 |
|-----------------|--------------|--------------|

left execution



| | | |
|-----------------|--------------|--------------|
| G55JBL04 | 749x749x1262 | 710x710x1184 |
|-----------------|--------------|--------------|

Safety handrail for corner installation with vertical arm at one end

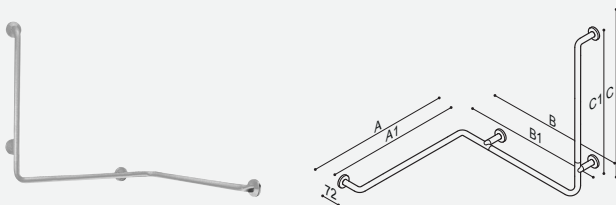

| Code | Dimensions (mm) | |
|------|-----------------|------------|
| | [AxBxC] | [A1xB1xC1] |

right execution



| | | |
|-----------------|--------------|--------------|
| G55JBR06 | 704x704x1262 | 665x665x1184 |
|-----------------|--------------|--------------|

left execution



| | | |
|-----------------|--------------|--------------|
| G55JBL06 | 704x704x1262 | 665x665x1184 |
|-----------------|--------------|--------------|

T-shaped safety handrail, equipped with adjustable hand shower holder

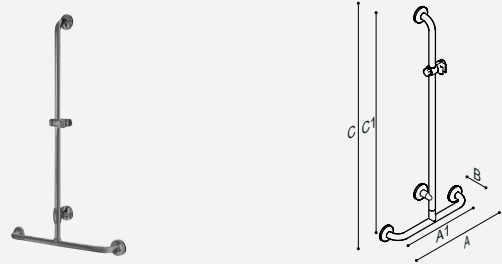

| Code | Dimensions (mm) | |
|------|-----------------|---------|
| | [AxBxC] | [A1xC1] |

| | | |
|-------------------|-------------|----------|
| G55JBS16xx | 548x72x1262 | 470x1184 |
|-------------------|-------------|----------|



Straight shower curtain rod

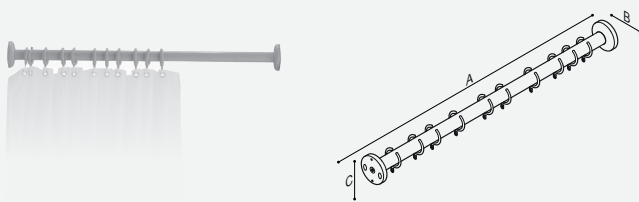

Code Dimensions (mm)
 [AxBxC]

| | |
|----------|------------|
| G55JRS01 | 800x78x78 |
| G55JRS02 | 900x78x78 |
| G55JRS03 | 1000x78x78 |
| G55JRS04 | 1100x78x78 |
| G55JRS05 | 1200x78x78 |
| G55JRS06 | 1300x78x78 |

Junction shower rod for ceiling mounting

| | |
|----------|------|
| Code | (mm) |
| G30JTS01 | 450 |



L-shaped shower curtain rod

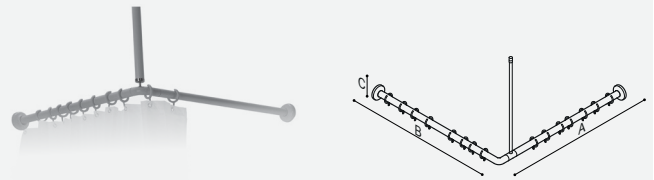

Code Dimensions (mm)
 [AxBxC] [A1xB1]

| | | |
|----------|--------------|-----------|
| G55JRS10 | 789x939x78 | 750x900 |
| G55JRS11 | 839x839x78 | 800x800 |
| G55JRS12 | 939x939x78 | 900x900 |
| G556RS13 | 1039x1039x78 | 1000x1000 |
| G55JRS14 | 1239x1239x78 | 1200x1200 |
| G55JRS15 | 1539x1539x78 | 1500x1500 |

Junction shower rod for ceiling mounting

| | |
|----------|------|
| Code | (mm) |
| G30JTS01 | 450 |



U-shaped shower curtain rod

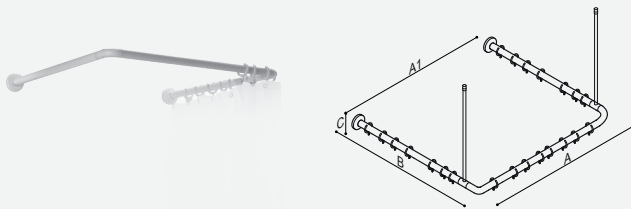

Code Dimensions (mm)
 [AxBxC] [A1]

| | | |
|----------|----------------|------|
| G55JRS25 | 650x978x650 | 900 |
| G55JRS20 | 800x878x800 | 800 |
| G55JRS21 | 900x978x900 | 900 |
| G55JRS22 | 1000x1078x1000 | 1000 |
| G55JRS23 | 1200x1278x1200 | 1200 |
| G55JRS24 | 1500x1578x1500 | 1500 |

Junction shower rod for ceiling mounting

| | |
|----------|------|
| Code | (mm) |
| G30JTS01 | 450 |





Seat and Stools

It is rare that a seat or a stool may be considered one of the most important and really essential element for safety into the bathroom. Everyone, regardless of gender, age, or capability may easily and quietly perform his daily functions such as washing the face or getting ready for a bath while comfortably seated.

To enhance this opportunity and assure a total safety, Ponte Giulio offers a wide choice of seats, stools and benches, which are conceived for and addressed to the various needs and areas of the bathroom: wash basin, shower or bathtub area.



Materials

Steel Aluminium

ABS Polyamide

Colours / Finishes

N1

Folding shower seat with supporting legs to the wall

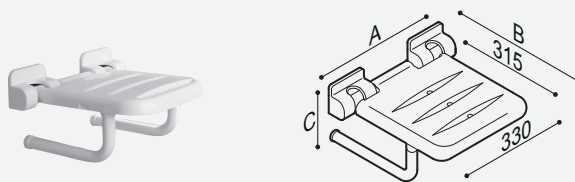

Code Dimensions (mm)
[AxBxC]

G20JDS25xx 420x390x237

Removable hanging shower seat

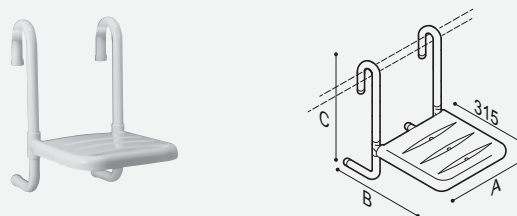

Code Dimensions (mm)
[AxBxC]

G01JDS24xx 330x535x530

Folding shower seat

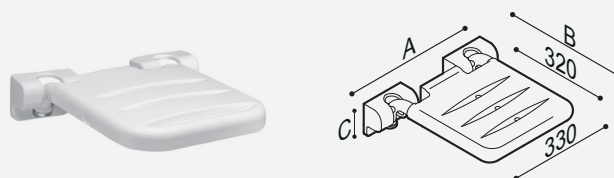

Code Dimensions (mm)
[AxBxC]

G01JDS42W1 428x415x124

Stool

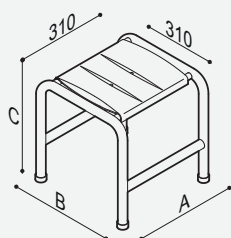

Code Dimensions (mm)
 [AxBxC]

G06JDS30W7 420x365x475

Removable bathtub seat

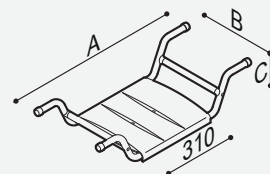

Code Dimensions (mm)
 [AxBxC]

G24JDS28W1 650x308x153

G24JDS29W1 700x308x153

Folding shower seat with supporting legs to the wall

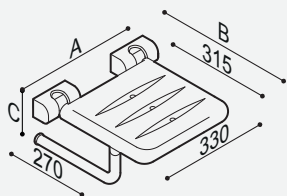

Code Dimensions (mm)
 [AxBxC]

G06JDS07W2 430x400x200

G06JDS07W7 430x400x200

Folding shower seat with supporting leg to the floor

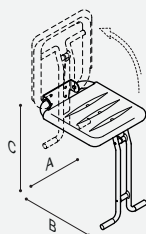

Code Dimensions (mm)
 [AxBxC]

G06JDS42W2 330x412x515

G06JDS42W7 330x412x515



Sanitaryware

The focal point of every bathroom are the wash basin and the shower tray, or alternatively the bathtub for people preferring the comfort of a relaxing bath.

Ponte Giulio's sanitaryware collection is offering a range of articles enabling body abled and physically challenged persons to enjoy their life into the bathroom in a quite safe way: toilet bowls and bidet 500 mm high, ergonomic wash basins and consoles with elbow rests and enough space for the knees when seated in front of them, last but not least the shower trays at floor level and walk-in bathtub with opening door.



Materials

Sanitary porcelain

Colours / Finishes

WB

Ergonomic wash basin, with elbow rests

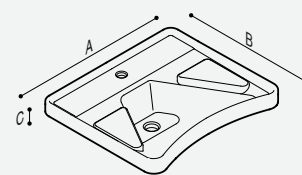

| Code | Dimensions (mm) [AxBxC] |
|------|----------------------------|
|------|----------------------------|

| | |
|-----------------|--------------------|
| B40CMS01 | 675x575x250 |
|-----------------|--------------------|

Pneumatic tilting mechanism for washbasin

Code

B41DAS05

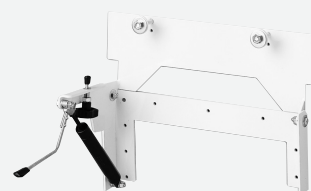

Supporting and fixing shelves

Code

B41DCS01



Floor standing toilet bowl with front opening



| Code | Dimensions (mm) [AxBxC] | Drain |
|----------|----------------------------|-------|
| B40CBO06 | 375x530x500 | floor |
| B40CBO07 | 375x530x500 | wall |

Seat with seat-cover

Code

B41DEO25



Hanging toilet bowl with front opening

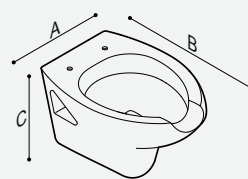

| Code | Dimensions (mm) [AxBxC] |
|----------|----------------------------|
| B40CAO02 | 365x545x390 |

Seat with seat-cover

Code

B41DEO26



Hanging toilet bowl

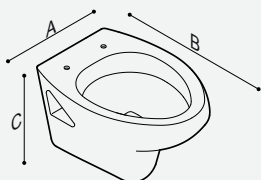

| Code | Dimensions (mm) [AxBxC] |
|----------|----------------------------|
| B40CAC02 | 365x550x390 |

Seat with seat-cover

Code

B41DEO26



Floor standing toilet bowl with front opening

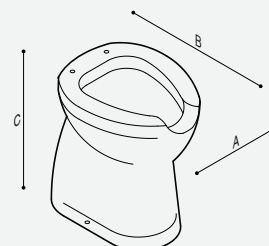

| Code | Dimensions (mm) [AxBxC] | Drain |
|----------|----------------------------|-------|
| B40CBO08 | 385x590x490 | floor |
| B40CBO09 | 385x590x490 | wall |

Seat with seat-cover

Code

B41DEO26



Sanitaryware

Raised toilet seat with front opening

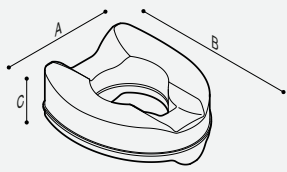

Code Dimensions (mm)
 [AxBxC]

B41DEO32 395x398x150

Raised toilet seat with lid, front opening

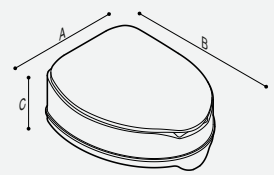

Code Dimensions (mm)
 [AxBxC]

B41DEO33 365x416x180





Bath accessories

Each bath environment may be furnished and custom-tailored with few but really essential decorative accessories, such as a mirror or a shower cabin, a towel holder or a brush holder. Ponte Giulio's wide range may satisfy the different tastes and exigencies for a private or public bathroom, a hotel or hospital bath unit, having different technical and aesthetic characteristics and performances but all with a must: to assure the utmost safety combined with style, elegance and long life.



Materials

Mirror

Steel

Aluminium

Safety glass

Accessories

Polyamide

Colours / Finishes

Mirror

W7

Accessories

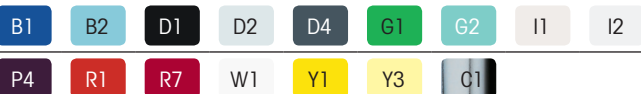

Tilting mirror in safety glass with frame

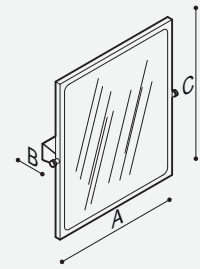

Code Dimensions (mm)
[AxBxC]

F41JPS25 552x100x600

Single robe hook with longer hook



Code Dimensions (mm)
[AxBxC]

F17AKN05xx 69x65x40

Paper roll holder

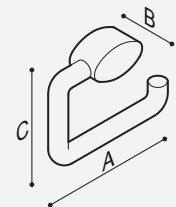

Code Dimensions (mm)
[AxBxC]

F17AGN04xx 150x35x121

Double robe hook

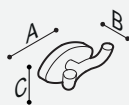

Code Dimensions (mm)
 [AxBxC]

F17AKN04xx 69x43x40

Corner sponge holder



Code Dimensions (mm)
 [AxBxC]

F17AON01xx 150x150x38

Paper roll holder for installation on grab bar

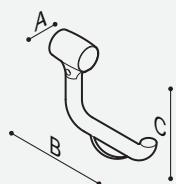

Code Dimensions (mm)
 [AxBxC]

F17AGN03xx 37x175x155

Glass holder with glass cup

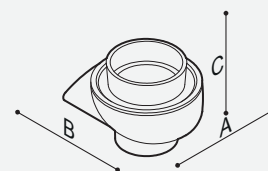
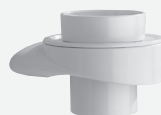

Code Dimensions (mm)
 [AxBxC]

F17ALN01xx 105x115x86

Toilet brush holder complete with brush

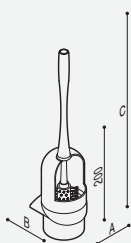

Code Dimensions (mm)
 [AxBxC]

F17AHN01xx 105x115x490

Soap holder



Code Dimensions (mm)
 [AxBxC]

F17AJN01xx 105x115x43

Bath Accessories

Single robe hook



Code Dimensions (mm)
 [AxBxC]

F17AKN03xx 69x45,5x40

Shower head holder

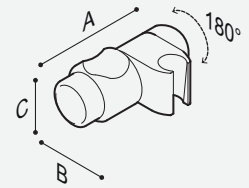

Code Dimensions (mm)
 [AxBxC]

| Code | Dimensions (mm) | Finish |
|-------------------|-----------------|----------|
| Y87JOS02xx | 117x78,5x44 | Coloured |
| Y87JOS02C1 | 117x78,5x44 | Chromed |

Shelf

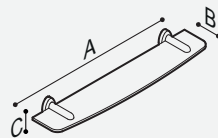

Code Dimensions (mm)
 [AxBxC]

F17ANN01xx 600x128x67





General information • flanges and fixing plates

Mounting flanges

Type of product on which these flanges are used:

- Grab bars
- Corner safety supports
- Fixed lateral supports
- Handrails

Tubocolor and Paint Ranges

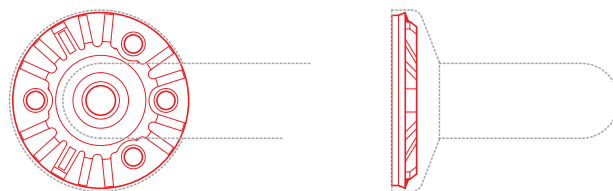

| | |
|-----------------|---|
| Name | 4 holes flange |
| Materials | fiber glass added polyamide |
| Dimensions (mm) | ø 80 |
| Reliefs | Suitable also for squared flange-cover option |

Stainless steel Range

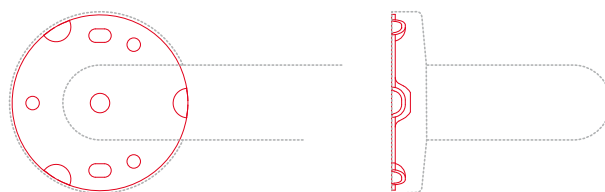

| | |
|-----------------|----------------------------|
| Name | 3 holes 2 slots flange |
| Materials | Stainless steel - AISI 304 |
| Dimensions (mm) | ø 77 |
| Reliefs | |

Mounting plates

Type of product on which these plates are used:

- Fold-down grab bar
- Side fixed supports
- Folding shower seats

Tubocolor, Paint Ranges

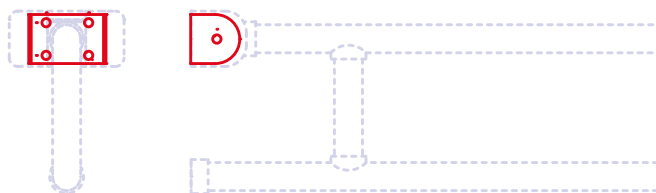

| | |
|-----------------|----------------------------|
| Name | 4 holes C-shaped plate |
| Materials | Stainless steel - AISI 304 |
| Dimensions (mm) | [WxDxH] 88,5x60x60 |
| Reliefs | |

Stainless steel Range

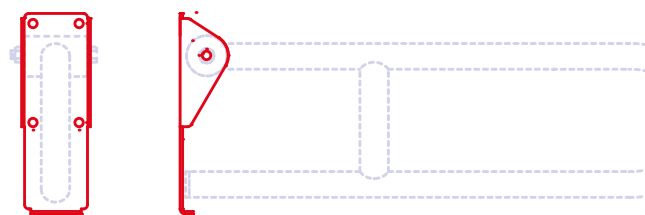

| | |
|-----------------|----------------------------|
| Name | 4 holes CL plate |
| Materials | Stainless steel - AISI 304 |
| Dimensions (mm) | [WxDxH] 82x57,5x239 |
| Reliefs | Satin finish |

Cleaning information

The information on this page are applicable only to products with vinyl surface



For the cleaning of the products do not use any powders or acid detergents or abrasive means, which may affect their surface and their functional features.

| | | | | | |
|---|-----------------------|---|-------------------------|---|----------------------|
| ▲ | Acetaldehyde | ◆ | Ethylene glycol | ◆ | Silver nitrate |
| ▲ | Acetamide | ◆ | Ethylic ether | ◆ | Soap solution |
| ● | Acetic acid | ◆ | Ferric chloride | ◆ | Sodium bisulphite |
| ◆ | Acetone | ◆ | Formaldehyde | ◆ | Sodium carbonate |
| ◆ | Acrylonitrile | ● | Formic acid | ◆ | Sodium chloride |
| ▲ | Alcoholic drinks | ◆ | Freon 12 liquid | ◆ | Sodium hypochlorite |
| ◆ | Alimentary fats | ◆ | Fuels petrol | ▲ | Sodium nitrate |
| ▲ | Aliyl alcohol | ▲ | Glycerine | ▲ | Sodium silicate |
| ◆ | Aluminium chloride | ◆ | Heptane | ◆ | Sodium sulphate |
| ◆ | Aluminium sulphide | ▲ | Hexane | ◆ | Sodium sulphide |
| ◆ | Ammonia | ● | Hydrochloric acid | ◆ | Sulphur |
| ◆ | Ammonium chloride | ● | Hydrogen peroxide | ◆ | Sulphurated hydrogen |
| ◆ | Amyl acetate | ● | Hydrofluoric acid | ● | Sulphuric acid |
| ◆ | Amyl alcohol | ● | Iodine | ▲ | Tartaric acid |
| ◆ | Aniseed oil | ● | Iodine sulphide | ◆ | Tetrahydrofurane |
| ▲ | Aniline | ◆ | Isooctane | ◆ | Tetralina |
| ◆ | Aniseed oil | ▲ | Isopropyl alcohol | ● | Thionyl chloride |
| ◆ | Barium chloride | ● | Lactic acid | ◆ | Toluol |
| ■ | Benzaidehyde | ◆ | Lead acetate | ◆ | Transformer oil |
| ▲ | Benzoic acid | ◆ | Lead stearate | ◆ | Trichloroethylene |
| ◆ | Benzol | ◆ | Linseed oil | ◆ | Triethanolamine |
| ■ | Benzol alcohol | ◆ | Magnesium chloride | ◆ | Vaseline |
| ▲ | Bitumen | ● | Mercurio chloride | ◆ | Vinyl chloride |
| ▲ | Boric acid | ◆ | Mercury | ◆ | Water |
| ◆ | Butter | ◆ | Methyl acetate | ▲ | Wine |
| ▲ | Buttiryic acid | ■ | Methyl chloride | ◆ | Xylene |
| ◆ | Butyl acetate | ▲ | Methyl alcohol | ▲ | Zink chloride |
| ▲ | Butyl alcohol | ◆ | Milk | ◆ | Zink oxide |
| ◆ | Butyl phtalate | ◆ | Mineral oils | | |
| ▲ | Butylene glycol | ◆ | Naphthalene | | |
| ● | Calcium chloride | ▲ | Nitrobenzol | | |
| ◆ | Camphor | ▲ | Nitromethane | | |
| ◆ | Carbon sulfide | ◆ | Oleic acid | | |
| ◆ | Caustic potash | ● | Oleum | | |
| ◆ | Caustic soda | ◆ | Otyl phthalate | | |
| ● | Chlorine | ▲ | Oxalic acid | | |
| ● | Chloroform | ● | Ozone | | |
| ● | Chromic acid | ◆ | Paraffin oils | | |
| ● | Citric acid | ▲ | Perfumes | | |
| ◆ | Clove oil | ◆ | Petroleum | | |
| ◆ | Cooking oils | ◆ | Petroleum ether | | |
| ◆ | Copper sulphide | ● | Phenol aqueous solution | | |
| ◆ | Copra oil | ● | Phosphoric acid | | |
| ◆ | Cyclohexane | ▲ | Phthalic acid | | |
| ◆ | Cyclohexanol | ▲ | Potassium bichromate | | |
| ◆ | Decahydronaphtalene | ▲ | Potassium bromide | | |
| ◆ | Dichlorofluorethylene | ◆ | Potassium carbonate | | |
| ◆ | Diesel oil | ◆ | Potassium nitrate | | |
| ◆ | Dimethylformamide | ● | Potassium permanganate | | |
| ◆ | Dioxane | ▲ | Propylic alcohol | | |
| ▲ | Ethyl acetate | ◆ | Salicylic acid | | |
| ▲ | Ethyl alcohol | ◆ | Silicone oils | | |
| ◆ | Ethyl chloride | | | | |

Key

- ◆ Good resistance
- ▲ Medium resistance
- Strongly attached
- Some attack

General information

Alphabetical index

The list of items, in this document, is proposed below ordered by part number, in alphanumeric mode.

| Code | Page | Code | Page | Code | Page | Code | Page |
|----------|------|----------|------|----------|------|----------|------|
| B40CAC02 | 31 | G01JBS08 | 10 | G06JAS14 | 14 | G55JBL06 | 25 |
| B40CAO02 | 31 | G01JBS09 | 10 | G06JBL04 | 17 | G55JBL19 | 22 |
| B40CBO06 | 31 | G01JBS10 | 10 | G06JBL19 | 15 | G55JBR04 | 25 |
| B40CBO07 | 31 | G01JBS11 | 10 | G06JBR04 | 17 | G55JBR06 | 25 |
| B40CBO08 | 31 | G01JBS12 | 10 | G06JBR19 | 15 | G55JBR19 | 22 |
| B40CBO09 | 31 | G01JBS17 | 9 | G06JBS01 | 14 | G55JBS03 | 23 |
| B40CMS01 | 30 | G01JBS18 | 9 | G06JBS02 | 14 | G55JBS04 | 23 |
| B41DAS05 | 30 | G01JCS01 | 8 | G06JBS03 | 14 | G55JBS16 | 25 |
| B41DCS01 | 30 | G01JCS03 | 8 | G06JBS16 | 17 | G55JCS05 | 23 |
| B41DEO25 | 31 | G01JCS05 | 7 | G06JCS05 | 15 | G55JCS07 | 23 |
| B41DEO26 | 31 | G01JCS07 | 7 | G06JCS07 | 15 | G55JCS09 | 24 |
| B41DEO32 | 32 | G01JCS09 | 8 | G06JCS12 | 16 | G55JCS10 | 24 |
| B41DEO33 | 32 | G01JCS10 | 8 | G06JCS14 | 16 | G55JCS12 | 24 |
| F17AGN03 | 8 | G01JCS12 | 8 | G06JCS21 | 24 | G55JCS14 | 24 |
| F17AGN03 | 35 | G01JCS14 | 8 | G06JCS38 | 15 | G55JCS16 | 23 |
| F17AGN04 | 34 | G01JCS38 | 7 | G06JCS39 | 15 | G55JOL01 | 23 |
| F17AHN01 | 35 | G01JCS39 | 7 | G06JCS52 | 16 | G55JOR01 | 23 |
| F17AJN01 | 35 | G01JCS52 | 9 | G06JDS07 | 29 | G55JRS01 | 26 |
| F17AKN03 | 36 | G01JCS53 | 9 | G06JDS30 | 29 | G55JRS02 | 26 |
| F17AKN04 | 35 | G01JDS24 | 28 | G06JDS42 | 29 | G55JRS03 | 26 |
| F17AKN05 | 34 | G01JDS42 | 28 | G06JOL01 | 15 | G55JRS04 | 26 |
| F17ALN01 | 35 | G01JEL01 | 6 | G06JOR01 | 15 | G55JRS05 | 26 |
| F17ANN01 | 36 | G01JEL02 | 6 | G06JOS01 | 17 | G55JRS06 | 26 |
| F17AON01 | 35 | G01JER01 | 6 | G06JRS01 | 18 | G55JRS10 | 26 |
| F41JPS25 | 34 | G01JER02 | 6 | G06JRS02 | 18 | G55JRS11 | 26 |
| G01JAS01 | 6 | G01JOL01 | 10 | G06JRS03 | 18 | G55JRS12 | 26 |
| G01JAS02 | 6 | G01JOR01 | 10 | G06JRS04 | 18 | G55JRS13 | 26 |
| G01JAS03 | 6 | G01JOS01 | 9 | G06JRS05 | 18 | G55JRS14 | 26 |
| G01JAS04 | 6 | G01JRS02 | 11 | G06JRS06 | 18 | G55JRS15 | 26 |
| G01JAS05 | 6 | G01JRS03 | 11 | G06JRS10 | 18 | G55JRS20 | 26 |
| G01JAS06 | 6 | G01JRS04 | 11 | G06JRS11 | 18 | G55JRS21 | 26 |
| G01JAS07 | 6 | G01JRS05 | 11 | G06JRS12 | 18 | G55JRS22 | 26 |
| G01JAS08 | 7 | G01JRS06 | 11 | G06JRS13 | 18 | G55JRS23 | 26 |
| G01JAS09 | 7 | G01JRS07 | 11 | G06JRS14 | 18 | G55JRS24 | 26 |
| G01JAS10 | 7 | G01JRS08 | 11 | G06JRS15 | 18 | G55JRS25 | 26 |
| G01JAS11 | 7 | G01JRS09 | 11 | G06JRS20 | 19 | Y87JOS02 | 36 |
| G01JAS12 | 7 | G01JRS11 | 11 | G06JRS21 | 19 | | |
| G01JAS13 | 7 | G01JRS12 | 11 | G06JRS22 | 19 | | |
| G01JAS17 | 6 | G01JRS13 | 11 | G06JRS23 | 19 | | |
| G01JAS18 | 6 | G01JRS14 | 11 | G06JRS24 | 19 | | |
| G01JAS19 | 7 | G01JRS15 | 11 | G06JRS25 | 19 | | |
| G01JAS20 | 7 | G01JRS22 | 11 | G20JDS25 | 28 | | |
| G01JAS41 | 6 | G01JRS23 | 11 | G24JDS28 | 29 | | |
| G01JAS42 | 6 | G01JRS24 | 11 | G24JDS29 | 29 | | |
| G01JAS43 | 6 | G01JTS10 | 11 | G30JTS01 | 19 | | |
| G01JAS44 | 6 | G01JTS11 | 11 | G55JAS01 | 22 | | |
| G01JBL19 | 9 | G01JTS12 | 11 | G55JAS02 | 22 | | |
| G01JBL20 | 9 | G01JTS13 | 11 | G55JAS03 | 22 | | |
| G01JBR19 | 9 | G06JAS02 | 14 | G55JAS04 | 22 | | |
| G01JBR20 | 9 | G06JAS03 | 14 | G55JAS05 | 22 | | |
| G01JBS01 | 8 | G06JAS05 | 14 | G55JAS06 | 22 | | |
| G01JBS02 | 8 | G06JAS06 | 14 | G55JAS07 | 22 | | |
| G01JBS03 | 8 | G06JAS08 | 14 | G55JAS11 | 23 | | |
| G01JBS04 | 8 | G06JAS09 | 14 | G55JAS14 | 22 | | |
| G01JBS05 | 8 | G06JAS10 | 14 | G55JAS15 | 22 | | |
| G01JBS06 | 10 | G06JAS12 | 15 | G55JAS38 | 22 | | |
| G01JBS07 | 10 | G06JAS13 | 14 | G55JBL04 | 25 | | |

Colour card and finishes

Tubocolor line

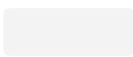
Standard 

W1
White

On request



B1
Blue



B2
Light Blue



D1
Black



D2
Grey Stone



D4
Dark Grey
Pantone 432



G1
Grass Green



G2
Light Green

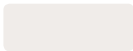

I1
Ivory

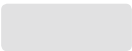

I2
Biscuit



P4
Prune
Pantone 262



R1
Red



R7
Ruby Red
RAL 3003



Y1
Sun Yellow



Y3
Light Yellow
Pantone 100

Paint line

Standard  

W2
Warm white
RAL 9010

W7
Linen white
RAL 9016

Inox, satin finish line

Standard 

N1
Satin finish

Above printed colours have to be considered as a mere guide, for the real colours please ask Ponte Giulio the colour sample.



PONTE GIULIO S.p.A.

Località Ponte Giulio 05018 Orvieto (TR) Italy

☎ +39 0763 316044

☎ +39 0763 316043

🌐 www.pontegiulio.it

PONTE GIULIO USA, Inc
W241 S4021 Rockwood Circle
Waukesha, WI 53189 USA
Phone 1.877.766.8301
Fax 1.877.766.8306
www.pontegiuliousa.com

UK OFFICE AND WAREHOUSE
Inprint House, 196 Old Shoreham Road, Hove
Sussex BN3 7EX - United Kingdom
🌐 www.pontegiulio.co.uk

